

INTRIGO 530 SOUS PLAN



Kitchen Sinks

Code: N453 S40

VASCA INTRIGO mm 530x400 R12 SOUSPLAN



DETAILS

Edge/Installation Type	Undermount
Material	AISI 304 stainless steel
Texture	Foster brushed
Base	80 cm
Dimensions	570x440 mm
Standard fittings	Fixing hooks, gasket, drain, overflow and siphon, boxed packing
Mixer holes	No standard holes
Built-in hole	View technical data sheet
Drainer	No

Width 57 cm

Bowl dimension 530x400mm

Number of bowls 1 bowl

Waste fitting Drain SPACE 3,5"

Notes: As the product consists of a single seamless steel surface with no gaps or interstices, the use of garbage disposal and waste fitting with automatic control is not permitted.

FEATURES

ONE SEAMLESS STEEL SURFACE The waste-fitting and overflow are moulded on the sink. The product is therefore made out of one seamless steel surface, without gaps or interstices. A great plus in terms of hygiene.

Deep bowls This bowls reach an important depth, over 20 cm, thanks to the advanced production technology, that can be offer great capiciency and practicity in all the washing operations.

High thickness 1mm thick steel. A significant thickness, which guarantees the maximum sturdiness and durability.

Perimetral overflow The overflow is always a security on the Foster sinks that prevents the overflow of water in case of oversights. The perimeter drain solution improves aesthetics thanks to its square and essential shape.

Save space system Drain and siphon are designed to leave as much space as possible in the under-sink area, more and more useful today for theseparate waste collection systems.

Small radius Bowls with squared shapes with a modern design and an increased capacity, for a minimal aesthetics connected with an extreme practicity.

Space waste fitting The elegant SPACE steel cap closes the drain and leaves no visible residues collected in the basket below. Space also has a small footprint and allows the optimal use of the under-sink compartment.

TECHNICAL DATA

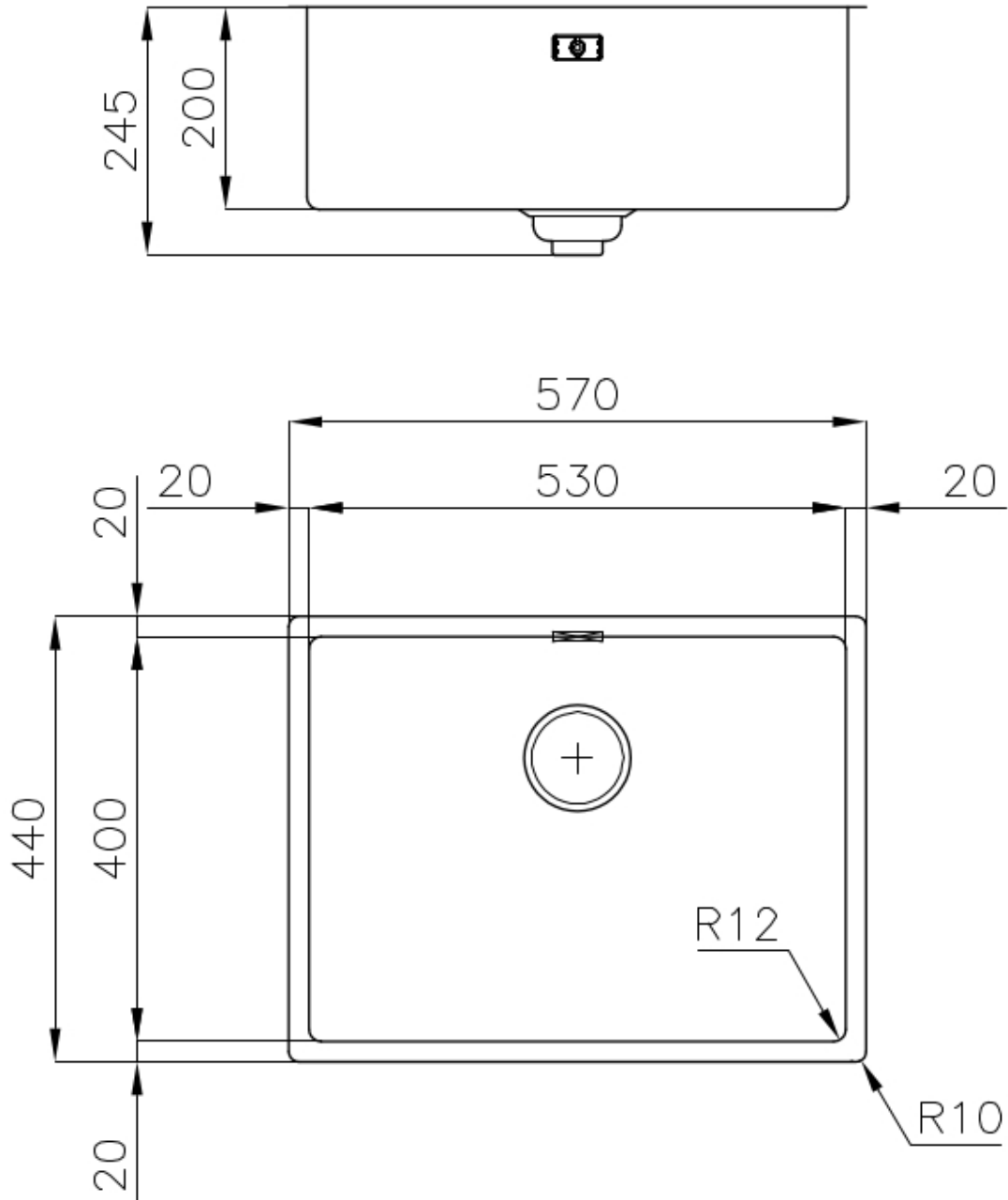

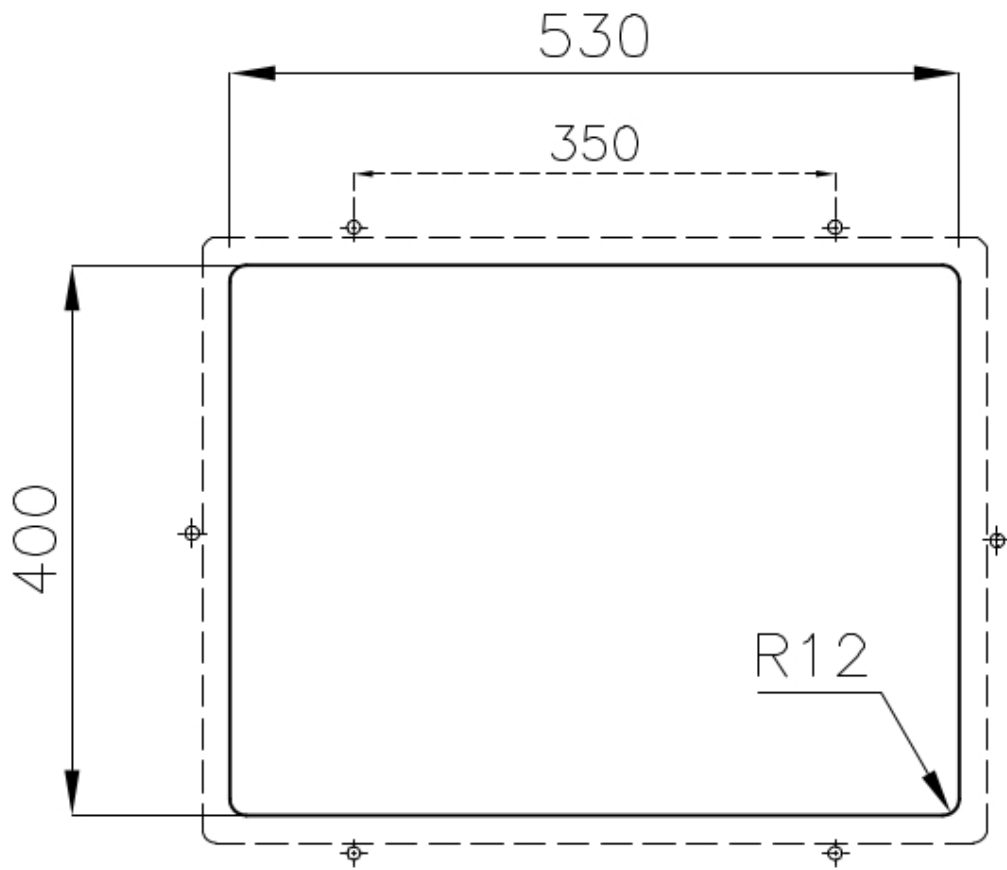

GALLERY



OPTIONAL ACCESSORIES



CUVETTE PERFOREE INOX

A154 F00

* only in combination with the accessory
A644 F04



CUVETTE PLASTIQUE BLANCHE

A153 A00

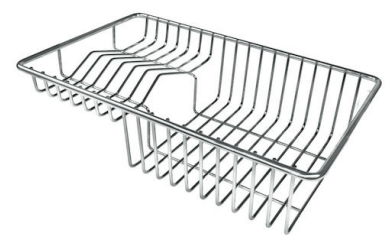

GRILLE POR.ASSIETTES INOX

mm214x379

A100 C03

* only in combination with the accessory
A644 A01

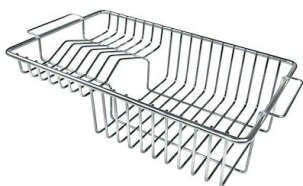

GRILLE PORTE-ASSIETTES INOX

250x425

A100 B01



GRILLE PORTE-ASSIETTES INOX

25x35

A100 A54

* only in combination with the accessory
A644 F04



PLANCHE DE DECOUPE CRYSTAL

23x41 CM

A631 C00



**PLANCHE DE DECOUPE DOUBLE
HDPE**
A644 A01



**PLANCHE DE DECOUPE DOUBLE
IROKO**
A644 F04



CUVETTE INOX PERFOREE
A151 F00
* only in combination with the accessory
A644 A01



**KIT RÂPES ET PLANCHE DE
DECOUPE HDPE**
A159 A01
* only in combination with the accessory
A644 A01



**PANIER INOX POUR CUVE 34x40
CM**
A611 F00



**PLANCHE DE DECOUPE DOUBLE
IROKO**
A644 F44

RECOMMENDED PAIRINGS



INCISO
R424 A00